

Axial compensation modules

Crash protectors

Alignment compensators

XY70 XY100 XY160 XY220 XY320 **XYZ70** XYZ100 XYZ160 XYZ220



- Sommer-automatic
- Grippers
- Separators
- Swivel units
- Rotating jaws
- Axial compensators**
- Tool changers
- Linear cylinders
- Shock absorbers
- Rotary cylinders
- Air vane motors
- Vacuum components
- Accessories
- Quick finder

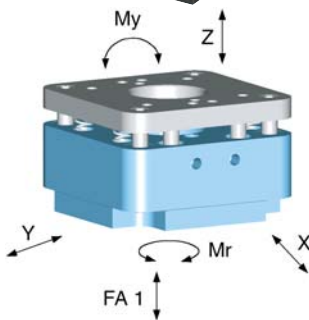

XYZ70

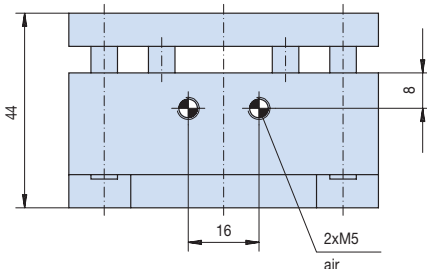
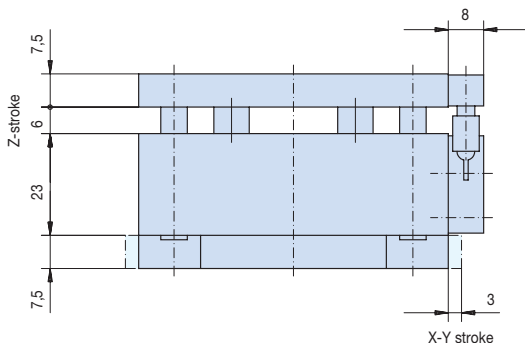
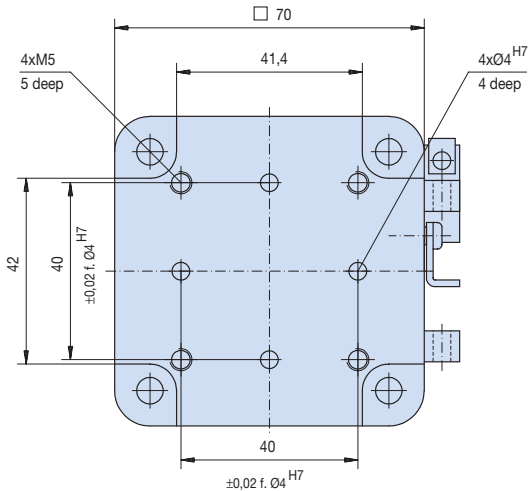

Axial compensation modules XYZ

Advantages, benefits, comparisons and tips! Stacks of information all about this product are on page 281.

Order no.:				
XYZ 70	XYZ 100	XYZ 160	XYZ 220	
Stroke X/Y ± [mm]:				
3	5	8	10	
Stroke Z-axis ± [mm]:				
6	10	16	25	
Centering force in XY-direction max. [N]:				
70	250	700	1200	
Spring force Z-axis min [N]:				
50	34	150	360	
Spring force Z-axis max. [N]:				
65	80	250	480	
Spring force Z-axis (spring set 2) min. [N]**				
60	40	200	445	
Spring force Z-axis (spring set 2) max. [N]**				
85	100	320	600	
Handling weight (recommended) [kg]:*				
6	12	30	150	
Tensile loading FA1 max. [N]:				
600	900	1500	2500	
Load Mr max. [Nm]:				
9	11	20	30	
Load My max. [Nm]:				
2,5	4,5	12	30	
Repeatability ± [mm]:				
0,05	0,05	0,05	0,05	
Min./max. operating pressure [bar]:				
4 / 8	4 / 8	4 / 8	4 / 8	
Min./max. operating temperature. [°C]:				
5 / 80	5 / 80	5 / 80	5 / 80	
Weight [kg]:				
0,6	1,6	6,1	19,0	

All data measured at 6 bar.

* with centric addition

** The Spring Set 2 is included separately and can be interchanged according to demand.

See Page 281 for Accessory list.

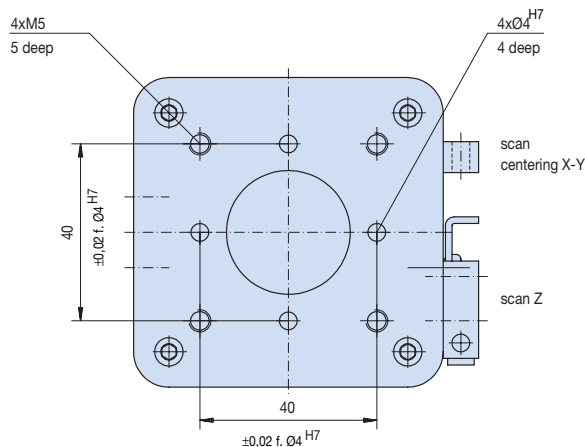

Axial compensation modules

Crash protectors

Alignment compensator

XY70

XY100

XY160

XY220

XY320

XYZ70

XYZ100

XYZ160

XYZ220



Drawing

XYZ100

Advantages, benefits, comparisons and tips!
Stacks of information all about this product are on page 281.

- Sommer-automatic
- Grippers
- Separators
- Swivel units
- Rotating jaws
- Axial compensators**
- Tool changers
- Linear cylinders
- Shock absorbers
- Rotary cylinders
- Air vane motors
- Vacuum components
- Accessories
- Quick finder

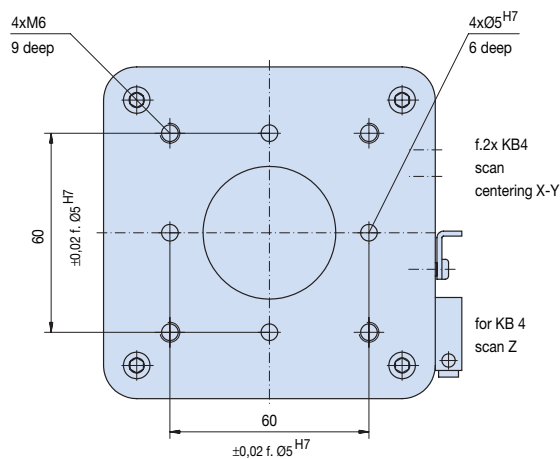
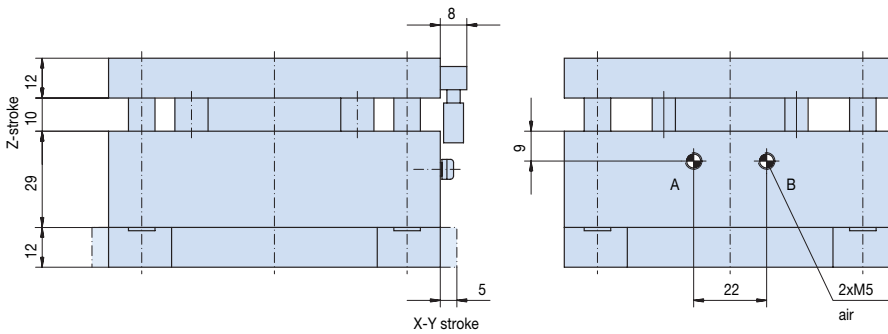
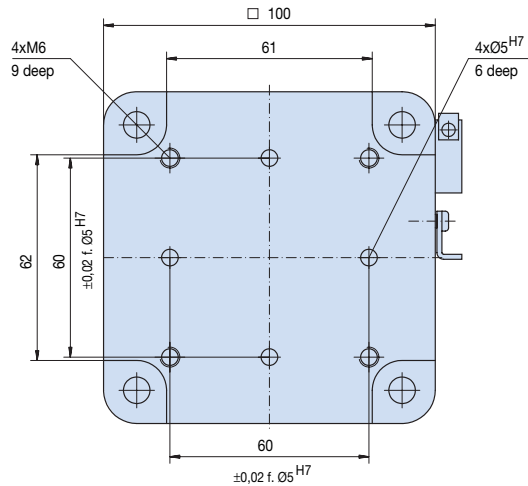

Axial compensation modules

Crash protectors

Alignment compensator

XY70

XY100

XY160

XY220

XY320

XYZ70

XYZ100

XYZ160

XYZ220



Drawing

XYZ220

Advantages, benefits, comparisons and tips!
Stacks of information all about this product are on page 281.

- Sommer-automatic
- Grippers
- Separators
- Swivel units
- Rotating jaws
- Axial compensators**
- Tool changers
- Linear cylinders
- Shock absorbers
- Rotary cylinders
- Air vane motors
- Vacuum components
- Accessories
- Quick finder

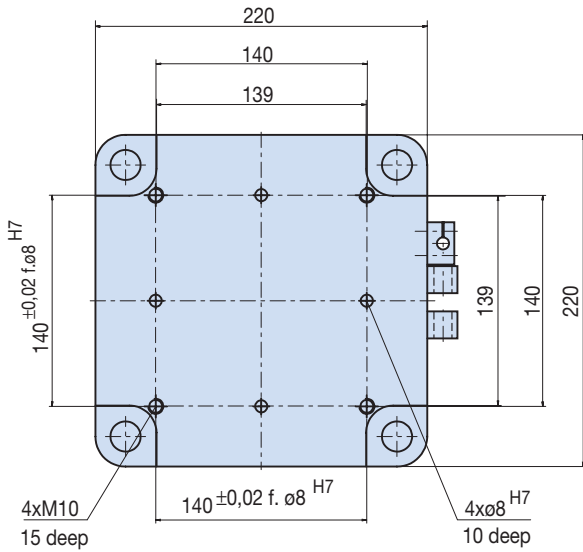

XYZ 220

