

Parallel Gripper

Three-jaw gripper

Angle gripper

Internal-hole gripper

Other grippers

Electric Gripper

GD29



Sommer-automatic

Grippers

Separators

Swivel units

Rotating jaws

Axial compensators

Tool changers

Linear cylinders

Shock absorbers

Rotary cylinders

Air vane motors

Vacuum components

Accessories

Quick finder

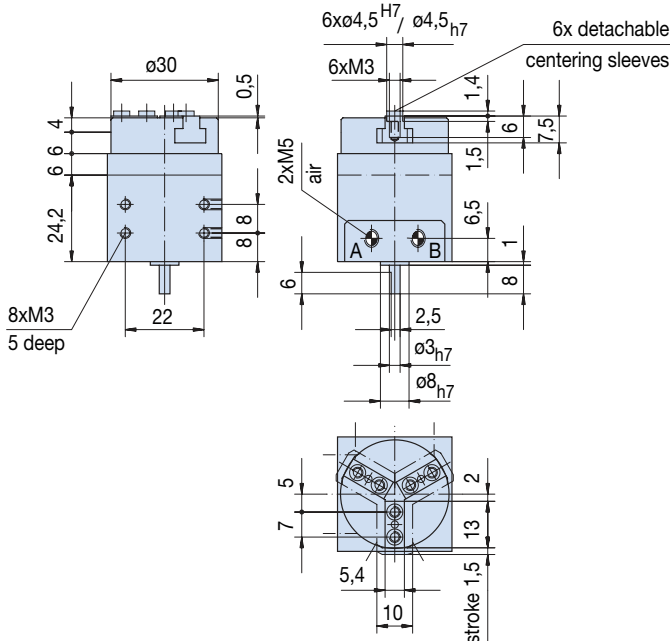
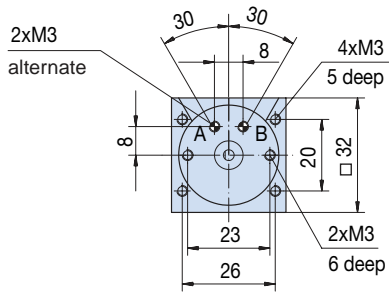
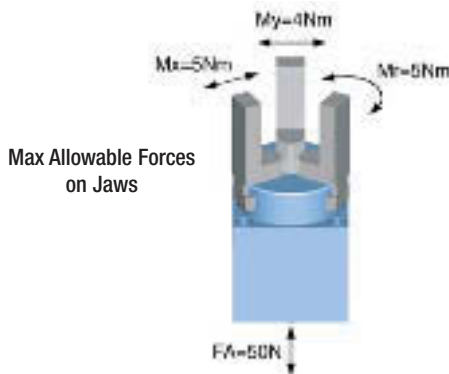

Three-jaw gripper with cam drive and T-slot guide

Advantages, benefits, comparisons and tips!
Stacks of information all about this product are
on page 139.

Order no.:	GD29			
Drive:	pneum.			
Stroke per jaw [mm]:	1,5			
Gripping force in closing and opening [N]:	45			
Self-locking via:	DSV1/8			
Closing time/opening time [s]:	0,03			
Repeatability ± [mm]:	0,02			
Min./max. operating pressure [bar]:	4/8			
Air volume per cycle [cm³]:	2			
Min./max. operating temperature. [°C]:	5/60			
Weight [kg]:	0,1			

All data measured at 6 bar.

See Page 139 for Accessory list.

Position sensing:

Order no. DB1
Rotation limiter

Order no. NJ3-E2/02
Stop with integrated inductive proximity switch

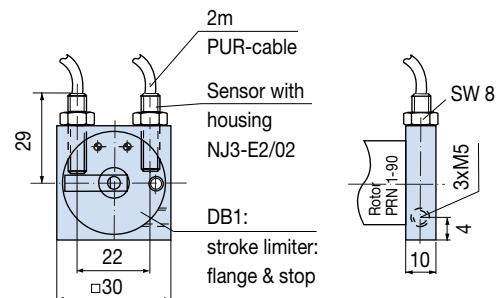

Gripper: quick to grip

Stop and think. Orientate. Surf on to destination!

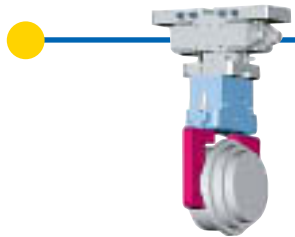

Parallel grippers
from page 15

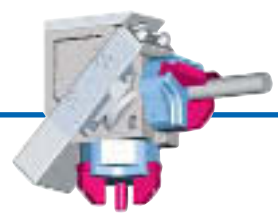

Three-jaw grippers
from page 101

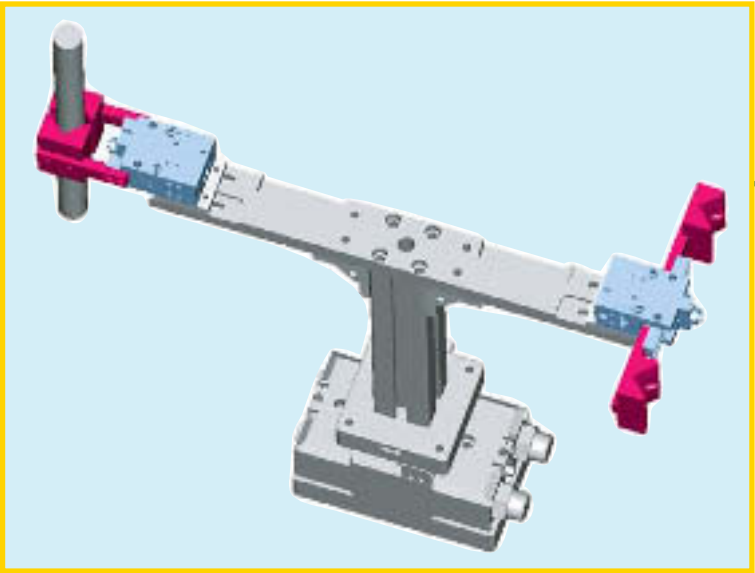

Angle grippers
from page 141

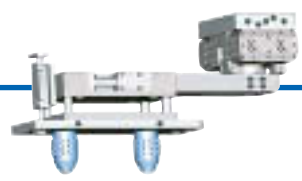

Internal-hole grippers
from page 163



Other grippers
from page 169

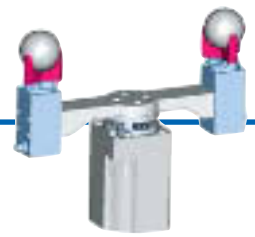

Electric grippers
Parallel grippers from page 183
Three-jaw grippers from p. 189

Angle gripper

Sealed Angle gripper

Product information about ...	143
GG25N	143.1
GG25NC	143.1
GG32N	143.2
GG32NC	143.2
GG50N	144
GG50NC	144
GG70N	145
GG70NC	145
GG100N	146
GG100NC	146

180° Pivoting arm gripper

Product information about ...	146.1
GK15N	148
GK20N	149
GK25N	150
GK35N	151
GK40N	152
GK50N	153

Bumpers for pivoting arm gripper

PB15N	154
PB20N	154
PB25N	154
PB35N	154
PB40N	154

Low cost angular grippers

Product information about ...	154.1
SGW14N	154.2
SGW14NC	154.2
SGW25N	154.3
SGW25NC	154.3
SGW35N	154.4
SGW35NC	154.4

Compliant finger gripper

Product information about ...	154.5
GZ8-16E	156
GZ8-16D	156
GZ11-18E	157
GZ18-23D	157
GZ25-35E	158
GZ25-35G	158
GZ25-35D	159
GZ55-65D	159

Mini-finger gripper

Product information about ...	160
GM10	162
GM16	162
GM16D	162
GM22D	162

